



HAMPDEN FENCE SUPPLY
Incorporated

Proud Craftsmen Skilled in the Manufacturing of Fence Fittings.

Specializing
in **QUALITY** Fittings

- Bands • Hinges • Ties •
- Aluminum Fittings •

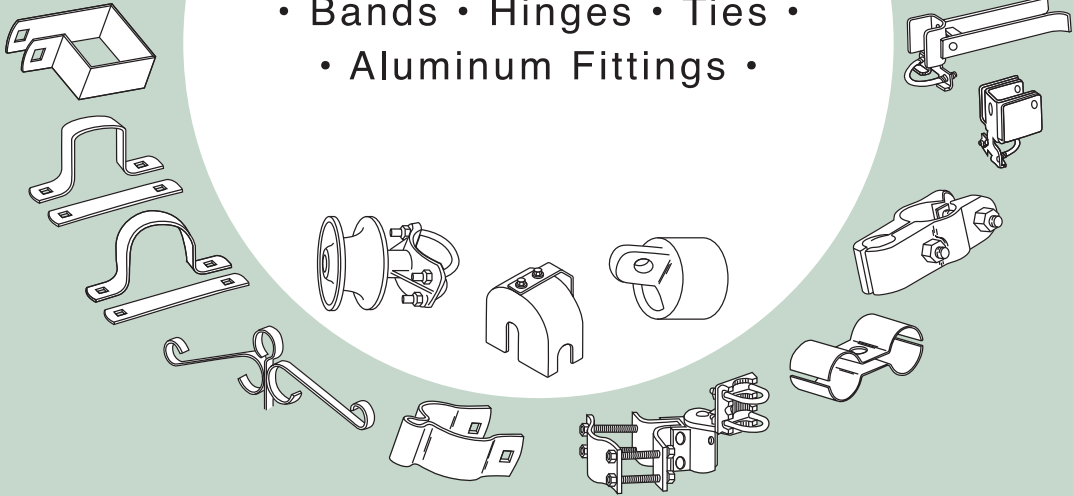

P.O.BOX 452 • 80 INDUSTRIAL LANE • AGAWAM, MA 01001
(413) 786-4390 • 1-800-891-2235 • Fax (413) 789-3664

www.hampdenfence.com

TERMS OF SALE

Our terms are 1% discount if paid in 10 days, otherwise net 30 days.
\$50 Minimum order. 10% Restocking charge.

Powdercoating Available - upcharge for colors other than black.



INDEX

Backstop Angle, Ductile Iron.....	9	Gate Hinges	
Barb Arms		Bull Dog Hinges, Pressed Steel	15
Barb Arm Bases	9	Female Gate Hinges, Pressed Steel.....	11
Steel Barb Arm Blades	9	Male Gate Hinges, Pressed Steel	11
Pressed Steel Corner Barb Arms.....	9	Malleable Frame Hinges.....	10
One Piece Barb Arms.....	9	Malleable & Pressed Steel Industrial Box Hinges ..	15
Brace Bands		180° Attachment	15
Beveled Brace Bands.....	2	Malleable & Pressed Steel Industrial Offset Hinges..	15
C Post and H Beam Brace Bands.....	4	Malleable Post Hinges	10
Corner Brace Bands, B	3	Gate Scrolls, Three Piece	12
Economy Brace Bands	1	Hog Rings, Aluminum.....	6
Heavy Brace Bands.....	5	Kennel Bands	16
Square Brace Bands	4	Locking Device Kits, 5 Piece Industrial	14
Two Way Brace Bands, Beveled	3	Locking Devices, Industrial	14
Three Way Brace Bands, Beveled.....	3	Locking Device Rods, Cane Bolt.....	14
Cantilever Gate Roller Guards.....	13	Loop Caps.....	8
Cantilever Gate Roller Latch Assemblies	14	Nuts and Bolts.....	19
Cantilever Gate Rollers, Malleable	13	Post Caps, Acorn and Dome.....	7
Cantilever Gate Rollers, Polymer & Nylon.....	13	Rail Ends	
Clamps		Combination Rail Ends.....	8
End Rail Clamps.....	17	Offset Rail Ends.....	8
Heavy End Rail Clamps.....	18	5" Rear Track Wheel.....	14
Heavy Line Rail Clamps	18	Tension Bands	
Kennel Clamps	16	Beveled Tension Bands.....	2
Line Rail Clamps	17	Economy Tension Bands.....	1
Saddle Clamps.....	16	Heavy Tension Bands.....	5
Steel Pipe Clamps.....	21	Square Tension Bands	4
Drive Anchor Units	22	Top Rail Sleeves	10
Duckbill Gate Holdbacks.....	10	Truss Rod Tighteners	12
Fence Ties, Aluminum	6	Welded Wire High Security Fence Hardware	23
Floor Flanges.....	19	Wood to Steel Adapters	21
Fork Latches, Pressed Steel	11		
Frame Clamps, Pressed Steel.....	12		
Fulcrum Latches, Heavy Duty	20		
Gate Clips.....	1		



B-1 TENSION BANDS - ECONOMY - Domestic
Hot Dipped Galvanized 14 Gauge x 3/4" Steel

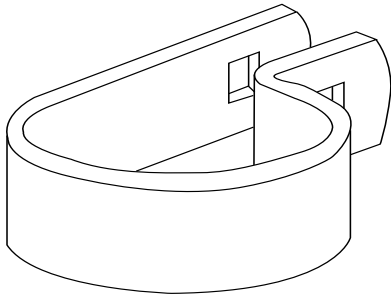

Part No.	Size	Carton	
		Weight	Quantity
TB138E	1 3/8" OD	75 LBS	500
TB158E	1 5/8" OD	78 LBS	500
TB200E	2" OD	68 LBS	400
TB250E	2 1/2" OD	54 LBS	300
TB300E	3" OD	44 LBS	200
USE CARRIAGE BOLTS			
NB516125	5/16" x 1 1/4"	46 LBS	1000

Available Powder Coated Black

GATE CLIPS
Hot Dipped Galvanized 12 Gauge x 5/8" Steel

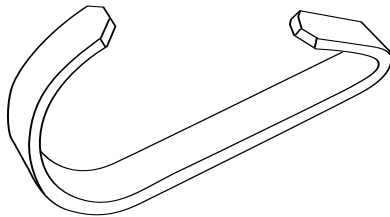

Part No.	Size	Carton	
		Weight	Quantity
GCE	1 3/8" OD	56 LBS	500

Available Powder Coated Black

B-6 BRACE BANDS - ECONOMY - Domestic
Hot Dipped Galvanized 12 Gauge x 3/4" Steel

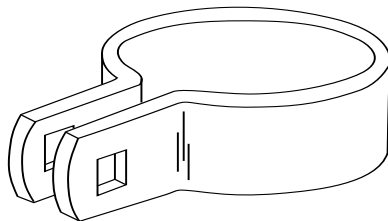

Part No.	Size	Carton	
		Weight	Quantity
BB138E	1 3/8" OD	60 LBS	500
BB158E	1 5/8" OD	64 LBS	400
BB200E	2" OD	54 LBS	300
BB250E	2 1/2" OD	66 LBS	300
BB300E	3" OD	63 LBS	250
USE CARRIAGE BOLTS			
NB516125	5/16" x 1 1/4"	46 LBS	1000

Available Powder Coated Black



B-1 TENSION BANDS - BEVELED - Domestic
Hot Dipped Galvanized 12 Gauge x 13/16" Steel

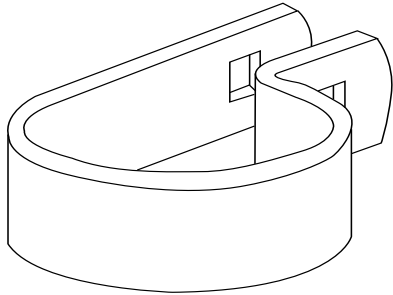

Part No.	Size	Weight	Carton Quantity
TB138B	1 3/8" OD	55 LBS	250
TB158B	1 5/8" OD	58 LBS	250
TB200B	2" OD	50 LBS	200
TB250B	2 1/2" OD	70 LBS	250
TB300B	3" OD	64 LBS	200
TB350B	3 1/2" OD	37 LBS	100
TB400B	4" OD	42 LBS	100
TB450B	4 1/2" OD	45 LBS	100
TB658B	6 5/8" OD	33 LBS	50
TB858B	8 5/8" OD	25 LBS	25
USE CARRIAGE BOLTS			
NB516125	5/16" x 1 1/4"	46 LBS	1000
Other sizes available as special order			

Available Powder Coated Black

B-6 BRACE BANDS - BEVELED - Domestic
Hot Dipped Galvanized 12 Gauge x 59/64" Steel

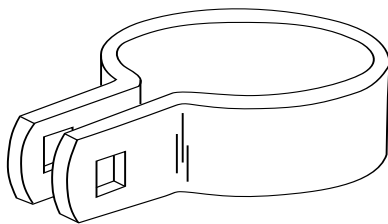

Part No.	Size	Weight	Carton Quantity
BB138B	1 3/8" OD	40 LBS	250
BB158B	1 5/8" OD	60 LBS	300
BB200B	2" OD	55 LBS	250
BB250B	2 1/2" OD	68 LBS	250
BB300B	3" OD	66 LBS	200
BB350B	3 1/2" OD	38 LBS	100
BB400B	4" OD	41 LBS	100
BB450B	4 1/2" OD	44 LBS	100
BB658B	6 5/8" OD	33 LBS	50
BB858B	8 5/8" OD	25 LBS	25
USE CARRIAGE BOLTS			
NB516125	5/16" x 1 1/4"	46 LBS	1000
Other sizes available as special order			

Available Powder Coated Black



B-7 CORNER BRACE BANDS 90° - BEVELED - Domestic
Hot Dipped Galvanized 12 Gauge x 59/64" Steel

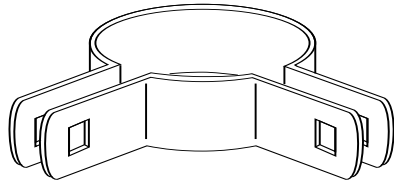

Part No.	Size	Weight	Carton Quantity
CBB200	2" OD	65 LBS	250
CBB250	2 1/2" OD	62 LBS	200
CBB300	3" OD	57 LBS	150
CBB400	4" OD	44 LBS	100
USE CARRIAGE BOLTS			
NB516125	5/16" x 1 1/4"	46 LBS	1000

Available Powder Coated Black

B-10 TWO WAY BRACE BANDS 180° - BEVELED - Domestic
Hot Dipped Galvanized 12 Gauge x 59/64" Steel

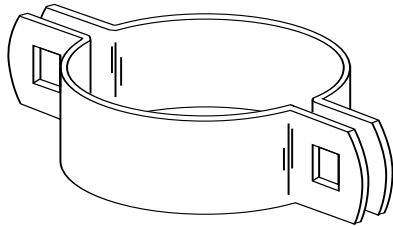

Part No.	Size	Weight	Carton Quantity
2WB200	2" OD	25 LBS	100
2WB200 available as special order of 2,000 pcs.			
2WB250	2 1/2" OD	27 LBS	100
2WB300	3" OD	34 LBS	100
2WB400	4" OD	50 LBS	100
USE CARRIAGE BOLTS			
NB516125	5/16" x 1 1/4"	46 LBS	1000

Available Powder Coated Black

THREE WAY BANDS - BEVELED - Domestic
Hot Dipped Galvanized 12 Gauge x 59/64" Steel

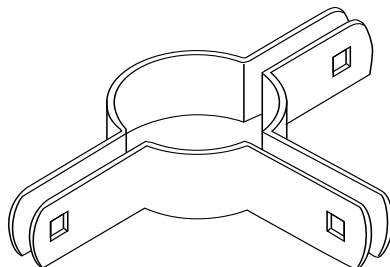

Part No.	Size	Weight	Bag Quantity
3WB250	2 1/5" OD	35 LBS	100
3WB300	3" OD	41 LBS	100
Use Carriage Bolts			
NB516125	5/16" x 1 1/4"	46 LBS	1000

Available Powder Coated Black



SQUARE TENSION BANDS - Domestic
 Hot Dipped Galvanized 12 Gauge x 13/16" Steel

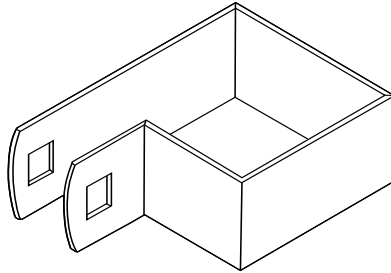

Part No.	Size	Bag	
		Weight	Quantity
TBSQ20	2" OD	69 LBS	250
TBSQ25	2 1/2" OD	66 LBS	200
TBSQ30	3" OD	53 LBS	150
TBSQ35	3 1/2" OD	40 LBS	100
TBSQ40	4" OD	24 LBS	50
TBSQ60	6" OD	35 LBS	50
Use Carriage Bolts			
NB516125	5/16" x 1 1/4"	46 LBS	1000
Other sizes available as special order			

Available Powder Coated Black

SQUARE BRACE BANDS - Domestic
 Hot Dipped Galvanized 12 Gauge x 59/64" Steel

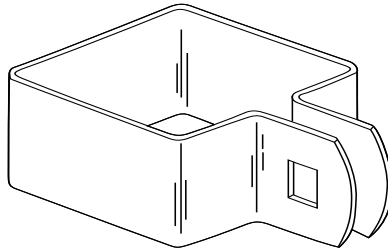

Part No.	Size	Bag	
		Weight	Quantity
BBSQ20	2" OD	72 LBS	250
BBSQ25	2 1/2" OD	54 LBS	200
BBSQ30	3" OD	58 LBS	150
BBSQ35	3 1/2" OD	40 LBS	100
BBSQ40	4" OD	24 LBS	50
BBSQ60	6" OD	34 LBS	50
Use Carriage Bolts			
NB516125	5/16" x 1 1/4"	46 LBS	1000
Other sizes available as special order			

Available Powder Coated Black

C POST AND H BEAM BRACE BANDS - Domestic
 Hot Dipped Galvanized 12 Gauge x 59/64" Steel

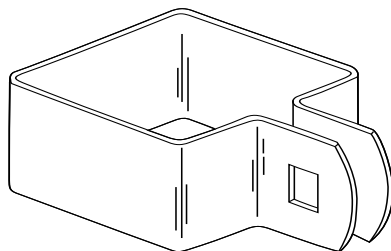

Part No.	Size	Bag	
		Weight	Quantity
BBLAC	LARGE C POST	63 LBS	250
Use Carriage Bolts			
NB516125	5/16" x 1 1/4"	46 LBS	1000
Other sizes available as special order			

Available Powder Coated Black



HEAVY TENSION BANDS - Domestic
Hot Dipped Galvanized 10 gauge x 1" Steel

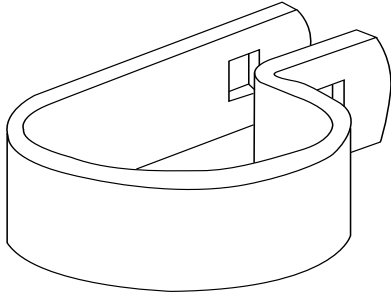

Part No.	Size	Carton	
		Weight	Quantity
TBHE15	1 ⁵ / ₈ " OD	67 LBS	200
TBHE20	2" OD	36 LBS	100
TBHE25	2 ¹ / ₂ " OD	41 LBS	100
TBHE30	3" OD	49 LBS	100
TBHE35	3 ¹ / ₂ " OD	55 LBS	100
TBHE40	4" OD	32 LBS	50
TBHE45	4 ¹ / ₂ " OD	38 LBS	50
TBHE65	6 ⁵ / ₈ " OD	50 LBS	50
USE CARRIAGE BOLTS			
NB38150	3/8" x 1 ¹ / ₂ "	88 LBS	1000
Other sizes available as special order			

Available Powder Coated Black

HEAVY BRACE BANDS - Domestic
Hot Dipped Galvanized 10 gauge x 1" Steel

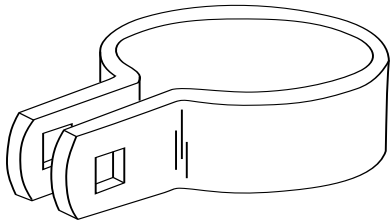

Part No.	Size	Carton	
		Weight	Quantity
BBHE20	2" OD	57 LBS	200
BBHE25	2 ¹ / ₂ " OD	36 LBS	100
BBHE30	3" OD	41 LBS	100
BBHE35	3 ¹ / ₂ " OD	47 LBS	100
BBHE40	4" OD	52 LBS	100
BBHE45	4 ¹ / ₂ " OD	33 LBS	50
BBHE65	6 ⁵ / ₈ " OD	49 LBS	50
USE CARRIAGE BOLTS			
NB38150	3/8" x 1 ¹ / ₂ "	88 LBS	1000
Other sizes available as special order			

Available Powder Coated Black



ALUMINUM FENCE TIES - Domestic

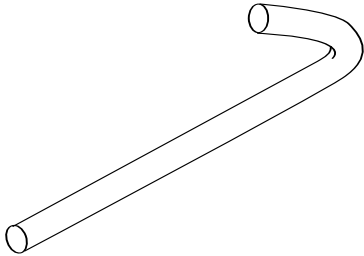

Part No.	Size	Length	Carton	
			Weight	Quantity
#13	9 GA	6 ¹ / ₂ "	47 LBS	3700
#16	9 GA	8 ¹ / ₄ "	48 LBS	3100
#23	6 GA	6 ¹ / ₂ "	39 LBS	1800
#26	6 GA	8 ¹ / ₄ "	48 LBS	1800

ALUMINUM WIRE COILS		
Size	Weight	Quantity
6 GA	35 LBS	29 FT/LB
9 GA	35 LBS	51.8 FT/LB

ALUMINUM BLACK WIRE		
Size	Weight	Quantity
6 GA	35 LBS	40 FT/LB
9 GA	35 LBS	64 FT/LB

Available Vinyl Coated Black

ALUMINUM HOG RINGS - Domestic

9 Gauge

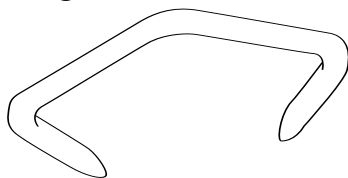

Part No.	Size	Approx Pieces/LB	Carton Weight
HOG9	9 GA	208	50 LBS

Available Vinyl Coated Black



ALUMINUM DOME CAPS - Domestic

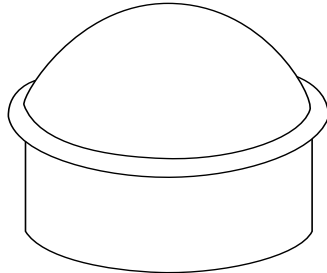

Part No.	Size	Bag	
		Weight	Quantity
ADC138	1 ³ / ₈ " OD	50 LBS	500
ADC158	1 ⁵ / ₈ " OD	75 LBS	500
ADC200	2" OD	53 LBS	250
ADC250	2 ¹ / ₂ " OD	70 LBS	250
ADC300	3" OD	45 LBS	100
ADC400	4" OD	36 LBS	50
ADC658	6 ⁵ / ₈ " OD	20 LBS	10

ALUMINUM ACORN POST CAP - Domestic

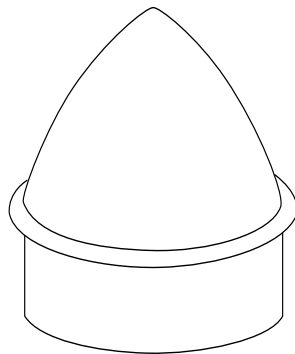

Part No.	Size	Bag	
		Weight	Quantity
APC138	1 ³ / ₈ " OD	49 LBS	350
APC158	1 ⁵ / ₈ " OD	60 LBS	300
APC200	2" OD	63 LBS	250
APC250	2 ¹ / ₂ " OD	64 LBS	200
APC300	3" OD	47 LBS	100
APC400	4" OD	50 LBS	50
APC658	6 ⁵ / ₈ " OD	19 LBS	10

Available Vinyl Coated Black

PRESSED STEEL POST CAPS

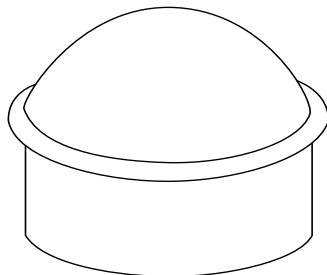

Part No.	Size	Bag	
		Weight	Quantity
PSPC158	1 ⁵ / ₈ " OD	28 LBS	200
PSPC200	2" OD	42 LBS	200
PSPC238	2 ³ / ₈ " OD	41 LBS	150
PSPC300	2 ⁷ / ₈ " OD	53 LBS	150
PSPC350	3 ¹ / ₂ " OD	46 LBS	100
PSPC400	4" OD	58 LBS	100
PSPC450	4 ¹ / ₂ " OD	74 LBS	100
PSPC658	6 ⁵ / ₈ " OD	15 LBS	10
PSPC858	8 ⁵ / ₈ " OD	18 LBS	8

Available Vinyl Coated Black



ALUMINUM LOOP CAPS - Domestic

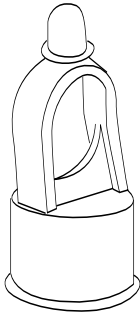

Part No.	Size	Weight	Bag Quantity
ALC158	1 ⁵ / ₈ " x 1 ³ / ₈ "	75 LBS	250
ALC213	2" x 1 ³ / ₈ "	60 LBS	200
ALC215	2" x 1 ⁵ / ₈ "	53 LBS	150
ALC255	2 ¹ / ₂ " x 1 ⁵ / ₈ "	75 LBS	100

Available Vinyl Coated Black

PRESSED STEEL LOOP CAPS

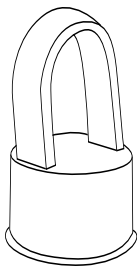

Part No.	Size	Weight	Carton Quantity
PSLC1513	1 ⁵ / ₈ " x 1 ³ / ₈ "	14 LBS	50
PSLC1515	1 ⁵ / ₈ " x 1 ⁵ / ₈ "	15 LBS	50
PSLC2138	2" x 1 ³ / ₈ "	17 LBS	50
PSLC2158	2" x 1 ⁵ / ₈ "	19 LBS	50
PSLC2358	2 ¹ / ₂ " x 1 ⁵ / ₈ "	23 LBS	50
PSLC3158	3 x 1 ⁵ / ₈ "	30 LBS	50
PSLC3558	3 ¹ / ₂ " x 1 ⁵ / ₈ "	42 LBS	50
PSLC4158	4 x 1 ⁵ / ₈ "	46 LBS	50
PSLC4558	4 ¹ / ₂ " x 1 ⁵ / ₈ "	52 LBS	50

Available Powder Coated Black

ALUMINUM OFFSET RAIL ENDS - Domestic

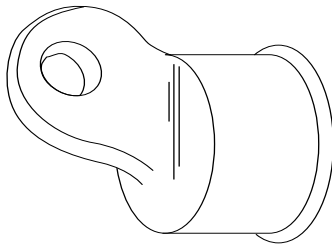

Part No.	Size	Weight	Bag Quantity
ARE138	1 ³ / ₈ " OD	38 LBS	250
ARE158	1 ⁵ / ₈ " OD	51 LBS	250

Available Vinyl Coated Black

PRESSED STEEL OFFSET RAIL ENDS

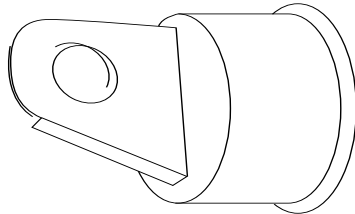

Part No.	Size	Weight	Bag Quantity
PSRE138	1 ³ / ₈ " OD	20 LBS	100
PSRE158	1 ⁵ / ₈ " OD	25 LBS	100
PSRE200	2" OD	31 LBS	100

Available Powder Coated Black

COMBINATION RAIL ENDS

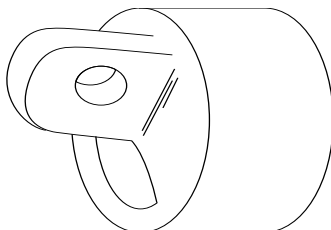

Part No.	Size	Weight	Bag Quantity
Malleable CRE158	1 ⁵ / ₈ " OD	42 LBS	100
Pressed Steel PSCRE158	1 ⁵ / ₈ " OD	22 LBS	100
PSCRE200	2" OD	26 LBS	100

Available Powder Coated Black



DUCTILE IRON BACKSTOP ANGLE

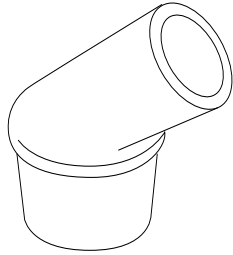

Part No.	Size	Weight	Bag Quantity
BAS	Fits 3" or 4" Post	51 LBS	12

STEEL BARB ARM BLADES

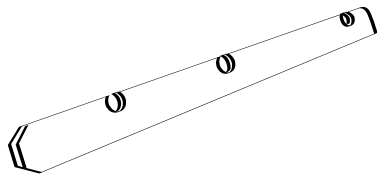

Part No.	Size	Weight	Bag Quantity
BARB ARM	3 STRAND	45 LBS	50

PRESSED STEEL CORNER BARB ARMS

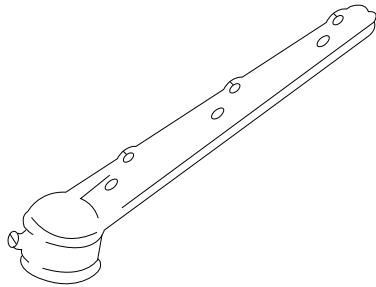

Part No.	Size	Weight	Bag Quantity
CBA250	2 1/2" OD	30 LBS	12
CBA300	3" OD	34 LBS	12
CBA400	4" OD	18 LBS	5

PRICES INCLUDE SET SCREW

ONE PIECE BARB ARMS

Available Powder Coated Black

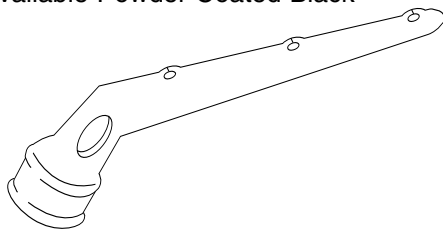

Part No.	Size	Weight	Bag Quantity
1PBA15	1 5/8" x 1 5/8"	30 LBS	25
1PBA20	2" x 1 5/8"	34 LBS	25
1PBA25	2 1/2" x 1 5/8"	40 LBS	25
1PBA30	3" x 1 5/8"	47 LBS	20

BARB ARM BASES - MALLEABLE

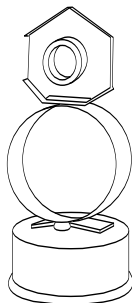

Part No.	Size	Weight	Bag Quantity
BAB2158	2" x 1 5/8"	64 LBS	50
BAB2558	2 1/2" x 1 5/8"	37 LBS	25



TOP RAIL SLEEVES

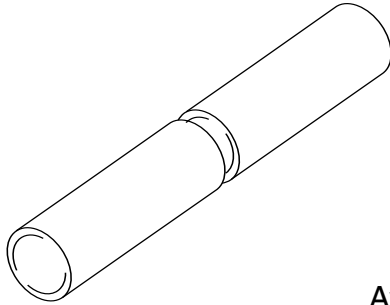

Part No.	Size	Weight	Bag Quantity
TRS138	1 ³ / ₈ " OD	32 LBS	100
TRS158	1 ⁵ / ₈ " OD	39 LBS	100

Available Powder Coated Black

FRAME HINGE - MALLEABLE
Residential Female Hinge

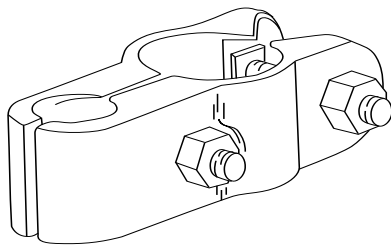

Part No.	Size	Weight	Bag Quantity
RFH138	1 ³ / ₈ " OD	38 LBS	50
RFH158	1 ⁵ / ₈ " OD	50 LBS	50
BOLTS INCLUDED			

POST HINGE - MALLEABLE
Residential Post Hinge

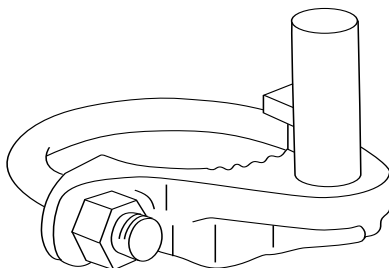

Part No.	Size	Weight	Bag Quantity
RPH200	2" OD	32 LBS	50
RPH250	2 ¹ / ₂ " OD	46 LBS	50
RPH300	3" OD	47 LBS	50
BOLTS INCLUDED			

DUCKBILL GATE HOLDBACKS
Ductile Iron

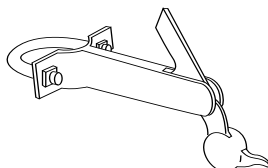

Part No.	Weight	Bag Quantity
DUCKHB	53 LBS	25
PRICE INCLUDES U-BOLT & 5/8" x 1 1/2" BOLTS		



FEMALE GATE HINGES - PRESSED STEEL
Hot Dipped Galvanized

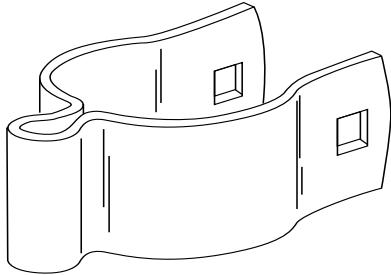

Part No.	Size	Carton	
		Weight	Quantity
FH138	1 ³ / ₈ " OD	30 LBS	100
FH158	1 ⁵ / ₈ " OD	38 LBS	100
FH200	2" OD	41 LBS	100
DOES NOT INCLUDE BOLTS			

Available Powder Coated Black

MALE GATE HINGES - PRESSED STEEL
Hot Dipped Galvanized

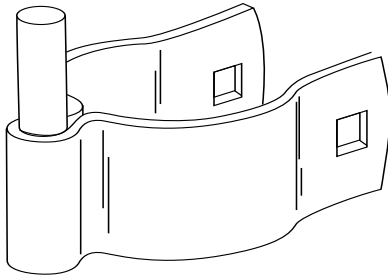

Part No.	Size	Carton	
		Weight	Quantity
MH138	1 ³ / ₈ " OD	46 LBS	100
MH158	1 ⁵ / ₈ " OD	55 LBS	100
MH200	2" OD	58 LBS	100
MH250	2 ¹ / ₂ " OD	63 LBS	100
MH300	3" OD	68 LBS	50
DOES NOT INCLUDE BOLTS			

Available Powder Coated Black

FORK LATCHES - PRESSED STEEL
Hot Dipped Galvanized

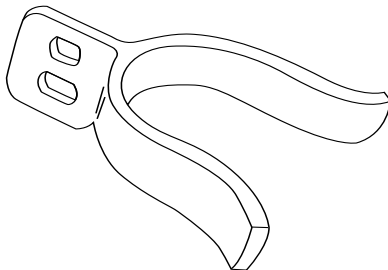

Part No.	Size	Bag	
		Weight	Quantity
FL138	1 ³ / ₈ " OD	35 LBS	100
FL158	1 ⁵ / ₈ " OD	39 LBS	100
FL200	2" OD	39 LBS	100
FL250	2 ¹ / ₅ " OD	42 LBS	100
FL300	3" OD	49 LBS	100
FL400	4" OD	39 LBS	50
DOES NOT INCLUDE BOLTS			

Available Powder Coated Black



FRAME CLAMPS - PRESSED STEEL

Hot Dipped Galvanized

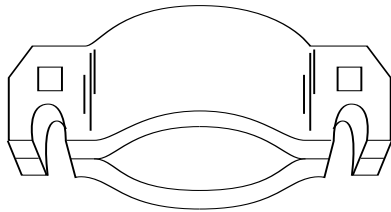

Part No.	Size	Weight	Carton Quantity
FC138	1 ³ / ₈ " OD	38 LBS	100
FC158	1 ⁵ / ₈ " OD	40 LBS	100
FC200	2" OD	50 LBS	100
DOES NOT INCLUDE BOLTS			

Available Powder Coated Black

GATE SCROLLS - THREE PIECE

Hot Dipped Galvanized 12 Gauge x 3/4" Steel

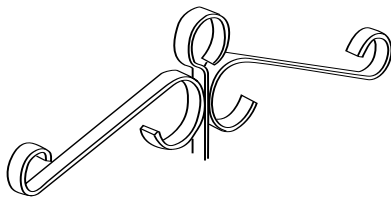

Part No.	Size	Weight	Bag Quantity
3PGS18	18" OD	49 LBS	50
3PGS24	24" OD	13 LBS	10
DOES NOT INCLUDE BOLTS			

Available Powder Coated Black

GATE TRUSS ROD TIGHTENERS

Standard Industrial - 1/4" x 4³/₄"

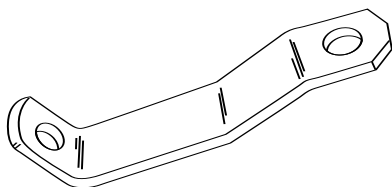

Part No.	Weight	Bag Quantity
TRT125	55 LBS	150
DOES NOT INCLUDE BOLTS		

Available Powder Coated Black

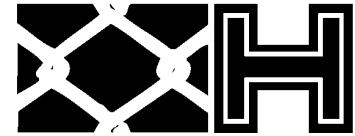

CANTILEVER GATE ROLLERS - MALLEABLE

Grease Needle Bearing

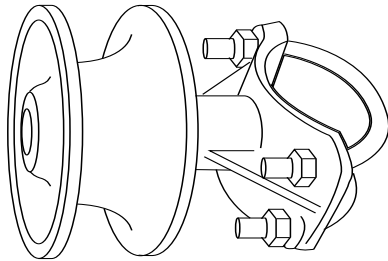

Part No.	Size	Carton	
		Weight	Quantity
CRH300	2 ⁷ / ₈ " x 2 ⁷ / ₈ "	24 LBS	4
CRH400	4" x 2 ³ / ₈ "	28 LBS	2
CRH658	6 ⁵ / ₈ " x 2 ³ / ₈ "	33 LBS	2

MINI CANTILEVER GATE ROLLERS - MALLEABLE

Sealed Ball Bearing

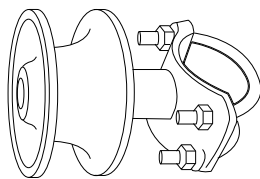

Part No.	Size	Carton	
		Weight	Quantity
CR250	2 ³ / ₈ " x 1 ⁵ / ₈ "	12 LBS	8

CANTILEVER GATE ROLLERS - NYLON - With Guards

SEALED BALL BEARING

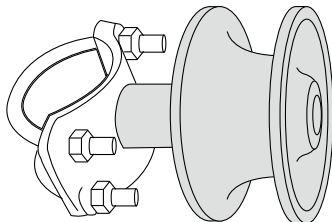

Part No.	Size	Carton	
		Weight	Quantity
NCR278	2 ⁷ / ₈ " x 2 ³ / ₈ "	46 LBS	4
NCR400	4" x 2 ³ / ₈ "	50 LBS	4

POLYMER CANTILEVER GATE ROLLERS - WITH GUARDS

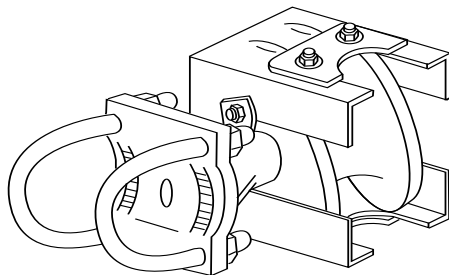

Part No.	Size	Carton	
		Weight	Quantity
PCR300	3" x 2 ¹ / ₂ "	33 LBS	2
PCR400	4" x 2 ¹ / ₂ "	37 LBS	2
PCR658	6 ⁵ / ₈ " x 2 ¹ / ₂ "	45 LBS	2

CANTILEVER ROLLER GUARDS

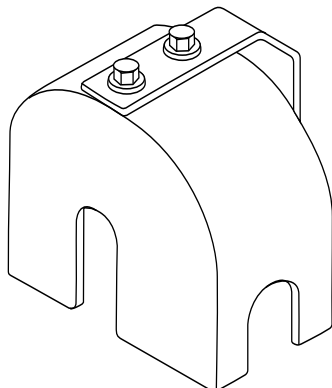

Made of 16 gauge hot dipped galvanized steel. It is designed to fit either round or square gate posts. Cover fits all standard 3" , 4" and 6⁵/₈" cantilever rollers. It covers the rollers completely while leaving access to grease fitting. Improves the look of the finished product.

Used only on top - Bottom is optional

Part No.	Size	Bag	
		Weight	Quantity
CRC	Fits 3" , 4" , 6 ⁵ / ₈ "	7 LBS	4



LATCH ASSEMBLY FOR CANTILEVER GATES - MALLEABLE

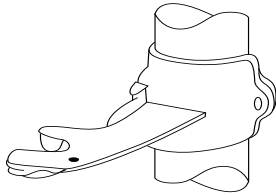

Part No.	Size	Carton	
		Weight	Quantity
CL300	3"	83 LBS	12
CL400	4"	88 LBS	12

Includes 2" Receiver

REAR TRACK WHEEL

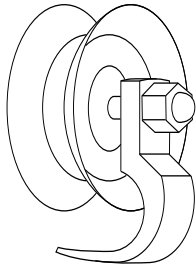

Part No.	Size	Carton	
		Weight	Quantity
5" Wheel	5"	66 LBS	10

INDUSTRIAL LOCKING DEVICE KIT - MALLEABLE

5 piece set, 1⁵/₈" or 2"

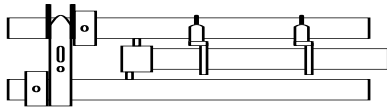

Part No.		Weight	Qty.
5PCILD	5 PIECE SET	55 LBS	8

Available Powder Coated Black

CANE BOLT ROD / DROP ROD



Part No.	Size	Bag	
		Weight	Quantity
DROP ROD	1/2" x 30" x 4"	44 LBS	25
DROP ROD	1/2" x 36" x 4"	51 LBS	25

Available Powder Coated Black

INDUSTRIAL DROP FORK AND GUIDE

Hot Dipped Galvanized Steel

Fits 2" Gate Frames

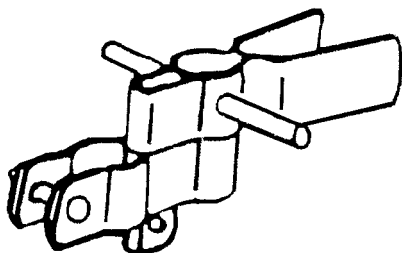

Part No.	Size	Bag	
		Weight	Quantity
ILDFOR158	1 ⁵ / ₈ " w/Pin	56 LBS	50
ILDFOR200	2" w/Pin	55 LBS	50
ILDGUI158	1 ⁵ / ₈ "	35 LBS	50
ILDGUI200	2"	36 LBS	50

Available Powder Coated Black



MALLEABLE INDUSTRIAL BOX HINGE COMPLETE

Ball And Socket Type - Fits Both 1⁵/₈" And 2" Gate Frame

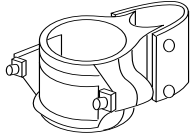

Available Powder Coated Black

Part No.	Size	Bag	
		Weight	Quantity
BOX250	2 ¹ / ₂ "	63 LBS	12
BOX300	3"	70 LBS	12
BOX400	4"	91 LBS	12
BOX658	6 ⁵ / ₈ "	63 LBS	4
BOX858	8 ⁵ / ₈ "	93 LBS	4

PRESSED STEEL INDUSTRIAL BOX HINGE

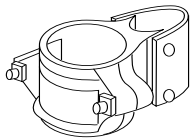

Available Powder Coated Black

Part No.	Size	Bag	
		Weight	Quantity
PSBOX250	2 ¹ / ₂ "	46 LBS	12
PSBOX300	3"	48 LBS	12
PSBOX400	4"	52 LBS	12
PSBOX658	6 ⁵ / ₈ "	23 LBS	4

MALLEABLE INDUSTRIAL BOX HINGE ATTACHMENT - 180°

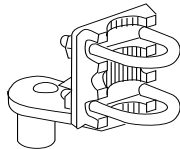

Available Powder Coated Black

Part No.	Size	Bag	
		Weight	Quantity
180ADA	1 ⁵ / ₈ " x 2"	66 LBS	12

BULL DOG HINGE PRESSED STEEL

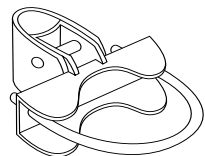

Available Powder Coated Black

Part No.	Size	Bag	
		Weight	Quantity
BDH250	2 ¹ / ₂ "	42 LBS	12
BDH300	3"	44 LBS	12
BDH400	4"	46 LBS	12
BDH658	6 ⁵ / ₈ "	22 LBS	4

MALLEABLE INDUSTRIAL OFFSET HINGES - Fits Both 1⁵/₈" And 2" Gate Frame

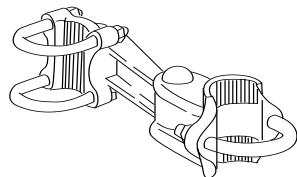

Available Powder Coated Black

Part No.	Size	Bag	
		Weight	Quantity
OFF238	2 ¹ / ₂ "	68 LBS	12
OFF300	3"	73 LBS	12
OFF400	4"	83 LBS	12
OFF658	6 ⁵ / ₈ "	53 LBS	4

PRESSED STEEL INDUSTRIAL OFFSET HINGES

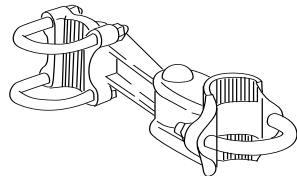

Available Powder Coated Black

Part No.	Size	Bag	
		Weight	Quantity
PSOFF238	2 ¹ / ₂ "	41 LBS	12
PSOFF300	3"	44 LBS	12
PSOFF400	4"	46 LBS	12
PSOFF658	6 ⁵ / ₈ "	24 LBS	4



KENNEL CLAMPS

Hot Dipped Galvanized 12 Gauge x 1 1/2" Steel

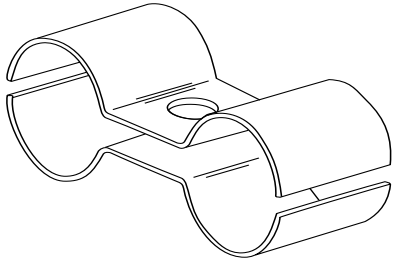

Part No.	Size	Weight	Bag Quantity
KENCLA12ga	1 3/8" x 1 3/8"	35 LBS	100
USE CARRIAGE BOLTS			
NB516125	5/16" x 1 1/4"	46 LBS	1000

Available Powder Coated Black

SADDLE CLAMPS - Domestic

Hot Dipped Galvanized 8 Gauge x 1 1/4" Steel

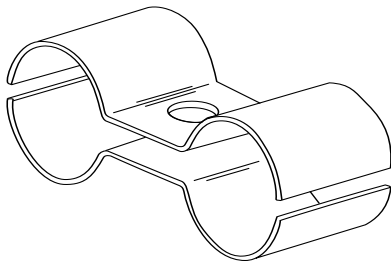

Part No.	Size	Weight	Carton Quantity
SC1515	1 5/8" x 1 5/8"	68 LBS	100
USE CARRIAGE BOLTS			
NB38150	3/8" x 1 1/2"	88 LBS	1000

Available Powder Coated Black

KENNEL BANDS - Domestic

Hot Dipped Galvanized 14 Gauge x 3/4" Steel

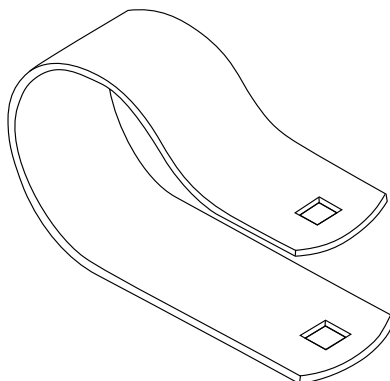

Part No.	Size	Weight	Carton Quantity
KENBAN	1 3/8" OD	71 LBS	500
USE CARRIAGE BOLTS			
NB516125	5/16" x 1 1/4"	46 LBS	1000

Available Powder Coated Black



END RAIL CLAMPS
Hot Dipped Galvanized 13 Gauge Steel

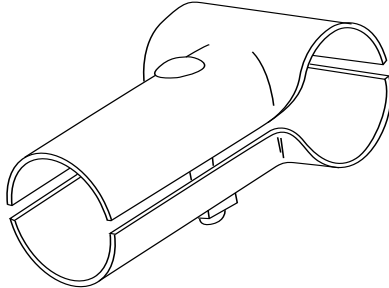

Part No.	Size	Bag	
		Weight	Quantity
EC1313	1 ³ / ₈ " x 1 ³ / ₈ "	40 LBS	100
EC1513	1 ⁵ / ₈ " x 1 ³ / ₈ "	35 LBS	100
EC2138	2" x 1 ³ / ₈ "	50 LBS	100
EC1515	1 ⁵ / ₈ " x 1 ⁵ / ₈ "	55 LBS	100
USE CARRIAGE BOLTS			
NB516250	5/16" x 2 1/2"	70 LBS	1000
DOMESTIC			
EC2158	2" x 1 ⁵ / ₈ "	55 LBS	100
EC2558	2 1/2" x 1 ⁵ / ₈ "	34 LBS	50
EC3158	3" x 1 ⁵ / ₈ "	37 LBS	50
EC3558	3 1/2" x 1 ⁵ / ₈ "	40 LBS	50
EC4158	4" x 1 ⁵ / ₈ "	42 LBS	50
USE CARRIAGE BOLTS			
NB38250	3/8" x 2 1/2"	98 LBS	1000
Also Available in 12 Gauge			
EC1313	1 ³ / ₈ " x 1 ³ / ₈ "		100

Available Powder Coated Black

LINE RAIL CLAMPS - Domestic
Hot Dipped Galvanized 13 Gauge Steel

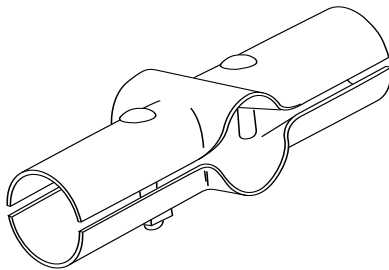

Part No.	Size	Carton	
		Weight	Quantity
LC1313	1 ³ / ₈ " x 1 ³ / ₈ "	60 LBS	100
LC1513	1 ⁵ / ₈ " x 1 ³ / ₈ "	60 LBS	100
LC2138	2" x 1 ³ / ₈ "	37 LBS	50
USE CARRIAGE BOLTS			
NB516250	5/16" x 2 1/2"	70 LBS	1000
LC1515	1 ⁵ / ₈ " x 1 ⁵ / ₈ "	38 LBS	50
LC2158	2" x 1 ⁵ / ₈ "	40 LBS	50
LC2558	2 1/2" x 1 ⁵ / ₈ "	50 LBS	50
LC3158	3" x 1 ⁵ / ₈ "	60 LBS	50
LC3558	3 1/2" x 1 ⁵ / ₈ "	65 LBS	50
LC4158	4" x 1 ⁵ / ₈ "	70 LBS	50
LCLAC	LRG C x 1 ⁵ / ₈ "	50 LBS	50
LCSRH	SRH x 1 ⁵ / ₈ "	50 LBS	50
USE CARRIAGE BOLTS			
NB38250	3/8" x 2 1/2"	98 LBS	1000

Available Powder Coated Black



HAMPDEN FENCE SUPPLY Incorporated

HEAVY END RAIL CLAMPS - Domestic
Hot Dipped Galvanized $\frac{3}{16}$ " Steel

Used by N.Y.C Parks Dept., N.Y.C School
 Construction Authority Board of Education,
 N.Y.D.O.T.

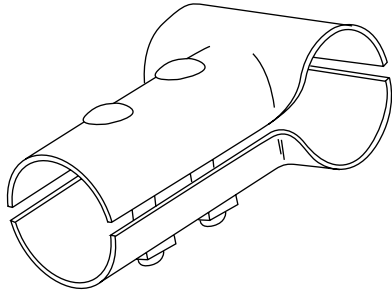

Part No.	Size	Weight	Bag Quantity
ECHE1515	1 $\frac{5}{8}$ " x 1 $\frac{5}{8}$ "	30 LBS	25
ECHE2158	2" x 1 $\frac{5}{8}$ "	31 LBS	25
ECHE2558	2 $\frac{1}{2}$ " x 1 $\frac{5}{8}$ "	38 LBS	25
ECHE3158	3" x 1 $\frac{5}{8}$ "	42 LBS	25
ECHE3558	3 $\frac{1}{2}$ " x 1 $\frac{5}{8}$ "	48 LBS	25
ECHE4158	4" x 1 $\frac{5}{8}$ "	53 LBS	25
USE CARRIAGE BOLTS			
NB38250	$\frac{3}{8}$ " x 2 $\frac{1}{2}$ "	98 LBS	1000

Corner Clamps Available. 20pc./Ctn.

Available Powder Coated Black

HEAVY LINE RAIL CLAMPS - Domestic
Hot Dipped Galvanized $\frac{3}{16}$ " Steel

Used by N.Y.C Parks Dept., N.Y.C School
 Construction Authority Board of Education,
 N.Y.D.O.T.

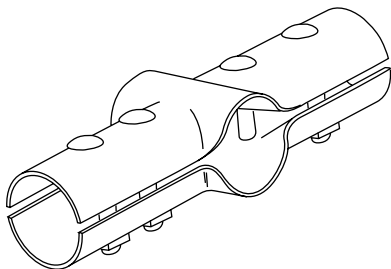

Part No.	Size	Weight	Carton Quantity
LCHE1515	1 5/8" X 1 5/8"	43LBS	25
LCHE2158	2" X 1 5/8"	43LBS	25
LCHE2558	2 1/2" X 1 5/8"	51LBS	25
LCHE3158	3" X 1 5/8"	54LBS	25
LCHE3558	3 1/2" X 1 5/8"	60LBS	25
LCHE4158	4" X 1 5/8"	65LBS	25
USE CARRIAGE BOLTS			
NB38250	3/8" X 2 1/2"	98LBS	1000

Corner Clamps Available. 20pc../Ctn.

Available Powder Coated Black



CARRIAGE BOLTS AND NUTS
Hot Dipped Galvanized

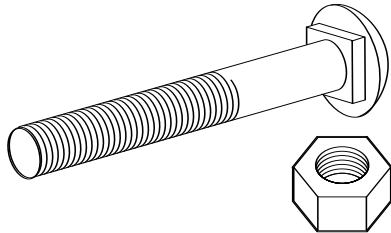

Select Sizes Available HDG
And Coated Black

Part No.	Size	Carton	
		Weight	Quantity
NB516125	5/16" x 1 1/4"	92 LBS	2000
NB516150	5/16" x 1 1/2"	48 LBS	1000
NB516175	5/16" x 1 3/4"	50 LBS	1000
NB516200	5/16" x 2"	60 LBS	1000
NB516250	5/16" x 2 1/2"	70 LBS	1000
NB516300	5/16" x 3"	72 LBS	1000
NB516350	5/16" x 3 1/2"	74 LBS	1000
NB516400	5/16" x 4"	76 LBS	1000
NB516450	5/16" x 4 1/2"	78 LBS	1000
NB38150	3/8" x 1 1/2"	88 LBS	1000
NB38200	3/8" x 2"	90 LBS	1000
NB38250	3/8" x 2 1/2"	98 LBS	1000
NB38300	3/8" x 3"	105 LBS	1000
NB38350	3/8" x 3 1/2"	65 LBS	500
NB38400	3/8" x 4"	70 LBS	500
NB38450	3/8" x 4 1/2"	80 LBS	500

MINIMUM ORDER OF 100 PIECES

FLOOR FLANGES
1/4" Thick

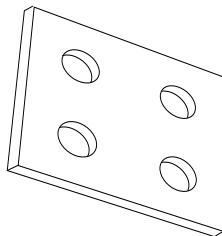

Part No.	Size	Carton/Bag	
		Weight	Quantity
FF3X6	3" x 6"	60 LBS	50
FF4X4	4" x 4"	50 LBS	50
FF5X5	5" x 5"	41 LBS	25
FF6X6	6" x 6"	45 LBS	20
FF8X8	8" x 8"	83 LBS	20



HEAVY DUTY FULCRUM LATCH
Hot Dipped Galvanized

DOUBLE LATCH

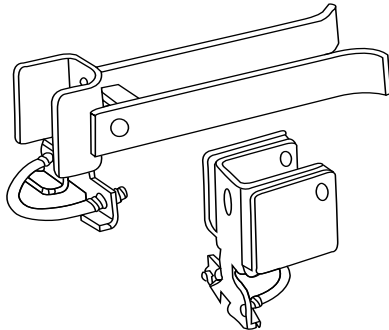

FL1717 DOUBLE

SINGLE LATCH

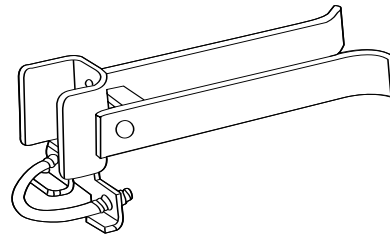

FL1730 SINGLE
FL1740 SINGLE

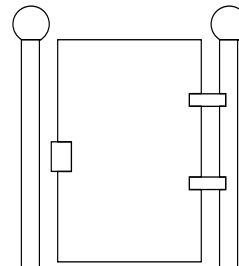
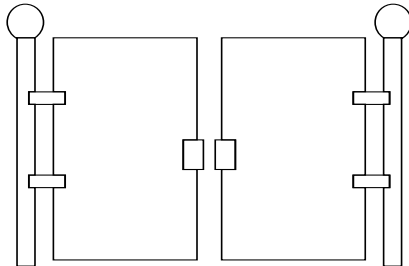

Part No.	Size	Description	Weight	Carton Quantity
FL1717 DOUBLE	17/8" x 17/8"	FITS 15/8" - 17/8" FRAME ADJ. 2"-6" GAP	50 LBS	6
FL1730 SINGLE	17/8" x 3"	FITS 15/8" - 17/8" FRAME FITS 3" POST ALLOWS 2"-4" GAP	42 LBS	8
FL1740 SINGLE	17/8" x 4"	FITS 15/8" - 17/8" FRAME FITS 4" POST ALLOWS 2"-4" GAP	45 LBS	8/CASE

Available Powder Coated Black



STEEL PIPE CLAMPS - WOOD TO STEEL ADAPTERS - Domestic
Hot Dipped Galvanized 12 Gauge x 5⁹/₆₄" Steel

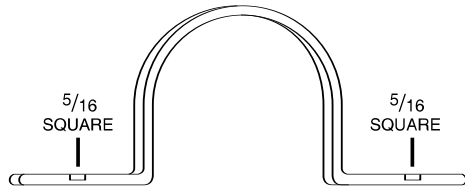

Part No.	Size	Weight	Carton Quantity
WSA158	1 ⁵ / ₈ " OD	21 LBS	100
WSA178	1 ⁷ / ₈ " OD	22 LBS	100
WSA250	2 ¹ / ₂ " OD	26 LBS	100
WSA300	3" OD	27 LBS	100
WSA400	4" OD	37 LBS	100

LINE ADAPTERS - WOOD TO STEEL

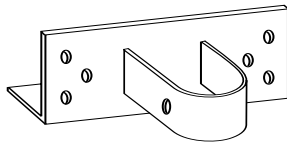

Part No.	Size	Weight	Carton/Bag Quantity
WSALINE	1 ⁵ / ₈ " x 6"	43 LBS	50
WSALINE	2" x 6"	44 LBS	50
WSALINE	2 ¹ / ₂ " x 6"	47 LBS	50
WSALINE	2" x 8"	52 LBS	50
WSALINE	2 ¹ / ₂ " x 8"	56 LBS	50
WSALINE	3" x 8"	58 LBS	50

END ADAPTERS - WOOD TO STEEL

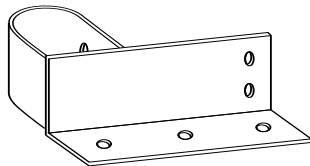

Part No.	Size	Weight	Carton/Bag Quantity
WSAEND	1 ⁵ / ₈ " x 6"	33 LBS	50
WSAEND	2" x 6"	33 LBS	50
WSAEND	2 ¹ / ₂ " x 6"	39 LBS	50
WSAEND	3" x 8"	54 LBS	50

CORNER ADAPTERS - WOOD TO STEEL

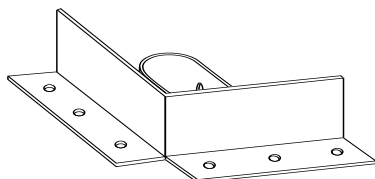

Part No.	Size	Weight	Carton/Bag Quantity
WSACorner	1 ⁵ / ₈ " x 6"	52 LBS	50
WSACorner	2" x 6"	53 LBS	50
WSACorner	2 ¹ / ₂ " x 6"	61 LBS	50
WSACorner	3" x 8"	64 LBS	50



DRIVE ANCHOR UNIT - Domestic

8 ga. x 1 1/4" Pressed Steel

Fits Posts Up To 3 1/2", JRH Beam, Small C Post and Square Post

Hot Dipped Galvanized Steel - Available with 5/16" or 3/8" hole

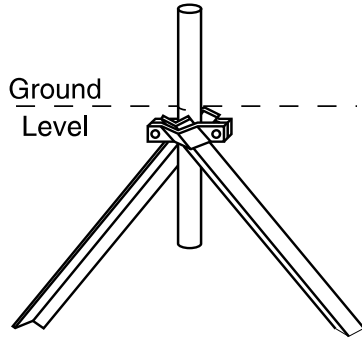

COMPLETE UNIT INCLUDES:

2 Anchor Blades 1" x 1" x 1/8" x 30" 2.05 LBS EA
 1 Shoe (Carton Qty. 50 sets) 33 LBS.Ctn
 2 Nuts and Bolts for Round Post 5/16" hole
 For length of bolt add 1" to size of pipe.

RDA COMPLETE UNIT Carton/Bundle
Part No. Weight Quantity

DAS516 1 SET PER UNIT 38 LBS 50 sets
 DAB10030 2 BLADES/UNIT

USES 2 CARRIAGE BOLTS EACH 3/8" hole

INDUSTRIAL DRIVE ANCHOR UNIT - Domestic

Fits Posts Up To 3 1/2" OD Post, SRH Beam, Large C Post and Square Post

Hot Dipped Galvanized Steel 8 ga. 1 1/4" Pressed Steel

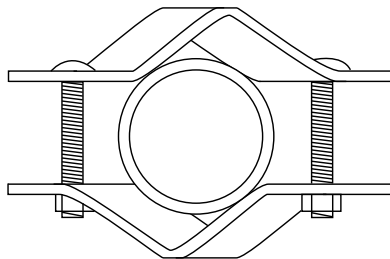

REQUIRES 2 - 1 1/4" x 1 1/4" x 1/8" x 30" Anchor Blades

REQUIRES 2 - Nuts + Bolts

REQUIRES 1 - Shoe

Part Carton/Bundle
No. Weight Quantity

DAS38 2pc. 38 LBS 50 sets
 DAB12530 1 1/4" x 1 1/4" x 1/8" x 30" 68 LBS 25 pc.
 DAB10030 1" x 1" x 1/8" x 30" 2.05 LBS EA
 DAB15030 1 1/2" x 1 1/2" x 1/8" x 30" 3.30 LBS EA

RECOMMENDED BOLT LENGTH

Square Post

2" Post - Use 3/8" x 4" Bolt
 2 1/2" Post - Use 3/8" x 4 1/2" Bolt
 3" Post - Use 3/8" x 5" Bolt
 3 1/2" Post - Use 3/8" x 5 1/2" Bolt

Round Post

1 1/2" Post - Use 3/8" x 3" Bolt
 2" Post - Use 3/8" x 3 1/2" Bolt
 2 1/2" Post - Use 3/8" x 4" Bolt
 3" Post - Use 3/8" x 4 1/2" Bolt
 3 1/2" Post - Use 3/8" x 5" Bolt
 SRH Post - Use 3/8" x 4" Bolt
 Heavy/Large C Post - Use 3/8" x 4" Bolt

DASLAR 2pc. - LARGE INDUSTRIAL DRIVE ANCHOR SHOE

Fits 4" and 4 1/2" Post, 8 ga. x 1 1/4" Pressed Steel, BOX: 50sets - 46 LBS



WELDED WIRE HIGH SECURITY FENCE HARDWARE - 10 gauge - Domestic

High security fence panels are attached to line posts, terminal posts and gate frames with 10 ga. x 1" hot dipped galvanized post brackets

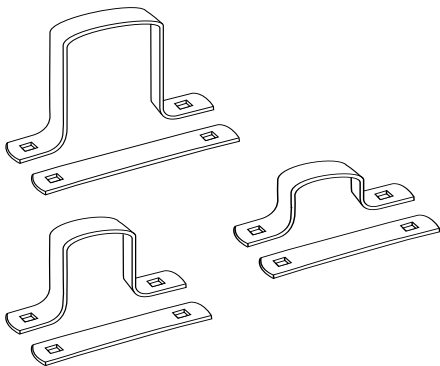

C POST BRACKET			
Part No.	Size	Weight	Quantity
HFSFC1625	1 ⁵ / ₈ " x 1 ¹ / ₄ "	48 LBS	100
HFSFC1700	1 ⁷ / ₁₀ " x 2 ¹ / ₄ "	53 LBS	100
HFSFC2500	2 ¹ / ₂ " x 3 ¹ / ₄ "	62 LBS	100
USE CARRIAGE BOLTS (2/Set)			
NB516125	5 ⁵ / ₁₆ " x 1 ¹ / ₄ "	46 LBS	1000

Available for Square Post

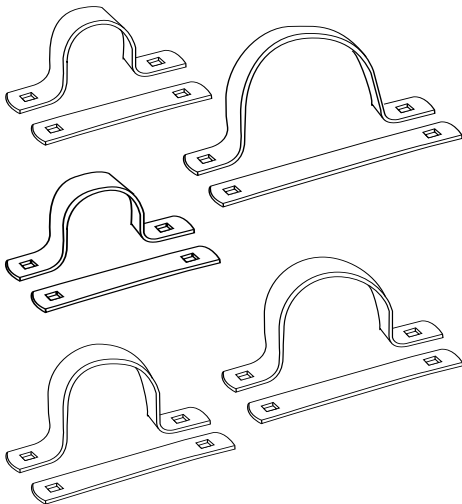

ROUND POST BRACKET			
Part No.	Size	Weight	Quantity
HFSF1660	1 ² / ₃ "	43 LBS	100
HFSF1875	1 ⁷ / ₈ "	47 LBS	100
HFSF2375	2 ³ / ₈ "	52 LBS	100
HFSF2875	2 ⁷ / ₈ "	64 LBS	100
HFSF3500	3 ¹ / ₂ "	72 LBS	100
HFSF4000	4"	82 LBS	100
HFSF4500	4 ¹ / ₂ "	45 LBS	50
HFSF6625	6 ⁵ / ₈ "	54 LBS	50
USE CARRIAGE BOLTS (2/Set)			
NB516125	5 ⁵ / ₁₆ " x 1 ¹ / ₄ "	46 LBS	1000
Special Order:			
HFSF5563	5 ⁹ / ₁₆ "	48 LBS	50
SUPERCLRC		66 LBS	50

Available Powder Coated Black